

Awning Instructions

Budget
1.5m to 4.5m

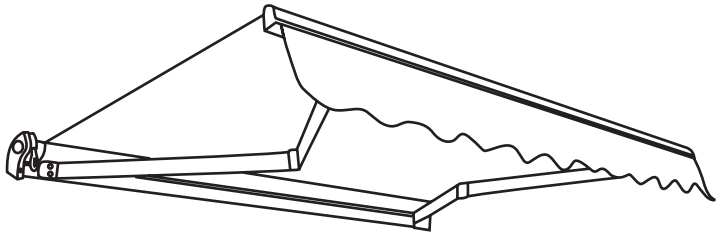

Budget Manual Instructions

Contents

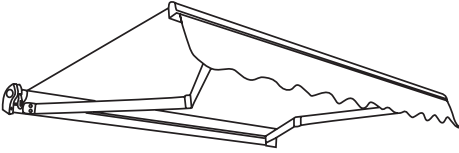
**1.5m - 3.0m Awnings**

- 4 x Expansion bolts (2 per bracket)**
- 2 x Wall brackets
- 1 x Awning
- 1 x Winder handle

3.5m - 4m Awnings

- 6 x Expansion bolts (2 per bracket)**
- 3 x Wall brackets
- 1 x Awning
- 1 x Winder handle

4.5m Awnings

- 8 x Expansion bolts (2 per bracket)**
- 4 x Wall brackets
- 1 x Awning
- 1 x Winder handle

Suggested Tools

- Hammer drill
- 14mm masonry drill bit
- Chalk or pencil to mark
- Laser level or long spirit level
- Metric socket spanner set
- Adjustable spanner

Warning

We recommend that two or more people are required to lift the awning into place.

The awning and frame may be supplied with a plastic wrapper. This should be removed prior to use.

Plastic bags can be dangerous to children and babies. Keep out of the reach of babies and children to avoid the risk of suffocation.

The awnings may be installed on wooden walls if the wall is sufficiently strong. Use appropriate screw-threaded or coach bolts.

**The expansion bolts supplied are for reinforced concrete or brick walls.

Guarantee

This awning is guaranteed against faulty parts and workmanship for one year from the date of delivery. Faulty parts will be replaced or exchanged within that period. The guarantee covers domestic use only.



Step 1: Determine position on the wall and mark up

Height of awning:

The recommended height from the ground is 2.5m-3.5m. If you want to install lower than this, determine whether there is sufficient headroom when the awning is fully extended and that any doors can open.

Required headroom:

– Allow 20cm above any door frame and check that when opened the door will not interfere with the awning.

– As a guideline, the awning has a drop of 30 cm (2m projection) to 45cm (2.5m projection) at a slope of 10 degrees below the horizontal.

The recommended slope is pre-set at the factory and should not require any major adjustment. The angle of drop can be adjusted with a spanner any time after fitting: from approx 15 – 30 degrees.

Horizontal positioning of brackets:

Using laser, spirit level or other method, mark an accurate horizontal line at the required height.

Fixing must be directly into brick or concrete. Mortar joints between the bricks or blocks will NOT be secure enough to bolt into.

Installing onto wooden houses and chalets:

You can install 1.5m -3.0m awnings onto wooden walls and chalets providing that the wall has adequate strength to support the weight of the awning. Always ensure that the wall brackets are securely fitted onto the outside of strong wooden wall studs.

The wall bolts provided in the fitting kit will not be suitable for securing to wooden studs; therefore you will need to purchase **Coach Bolts** of sufficient length and diameter from your local hardware store to replace the wall bolts (expansion bolts) provided. If unsure, consult a qualified structural engineer for expert advice.

Side view

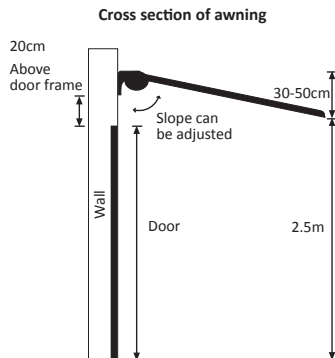

Step 2: Drill holes

Draw a horizontal line in the position of the required height.

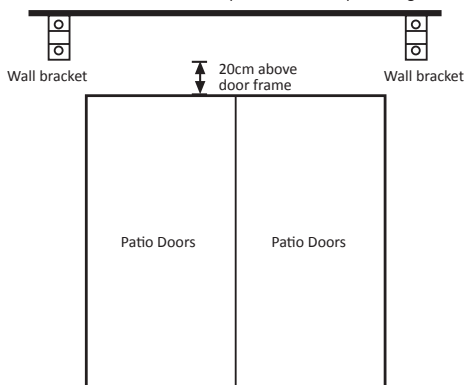

If in doubt about the quality of the wall structure you are wanting to mount the awning on, you can use an epoxy resin product to secure the mountings in the wall.

1. Attach the wall brackets onto the fixed external brackets located at the back of the cassette body. Measure the awning with a ruler and note down the bracket position (holes).
 2. Draw a horizontal line in the position of the required height as shown in the diagram.
 3. Make marks onto the wall, through the holes at the base of the bracket.
- Please double check your measurements thoroughly before drilling holes into your wall, especially if you're using a template. We will not be held responsible for any errors or incorrect measurements.**
4. Use a hammer-action electric drill with a 14mm bit. **Do NOT drill through mortar** as this will not provide satisfactory strength to hold the wall expansion bolts.
 5. Drill 90mm holes into brick or concrete wall in exact position chosen for wall brackets.
 6. Insert an expansion bolt into the drilled hole.

Expansion bolt

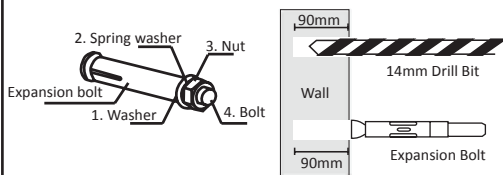

The bolt must stick out of the wall in order to attach the wall bracket, washer and nut. (View Step 3)

Step 3: Attach the brackets

1. Remove the nut and one of the washers from the expansion bolts that are now on the walls.
2. Fit bracket into place over wall bolt. Slide the remaining washer and nut then tighten with a socket spanner.
3. Ensure the bracket is tight against wall before fitting the awning as the weight of the awning could pull the brackets out of the wall. If any movement is detected, further tighten the nuts.

Fixing must be directly into brick or concrete. Mortar joints between the bricks or blocks will NOT be secure enough to bolt into.

Step 4: Install the awning

Note:

When installing 1.5m - 3.5m budget manual awning we recommend to use two step ladders with two people. 4.0m - 4.5m awnings are heavy, more than three people will be required to lift the awning into place. Do not attempt to lift this awning onto the wall brackets without assistance.

Lift both ends of the awning unit until the torsion bar (main back bar of awning) slides into the wall brackets.

Ensure the fabric is feeding from the top and not the bottom.

Fix the retaining bolts through the wall brackets to secure the awning unit in place. Fit the nut onto the bolt and tighten.

Check that both the wall bracket and the retaining bolts are tightened securely.

Wall bracket

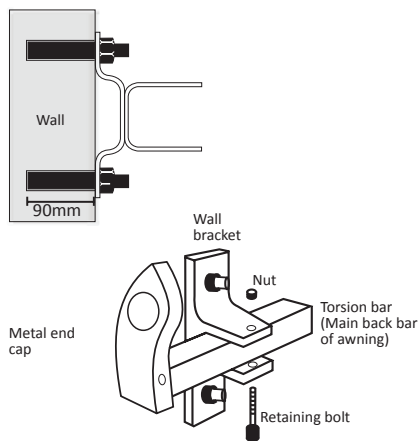

Step 5: Levelling the front bar – Adjust the angle

The awning is usually supplied with the most ideal pre-set angle of tilt. When fully opened, the front bar should be level. The angle can however be adjusted (adjustment on the arms next to the awning body).

Although level when fully projected, the awning may not be perfectly level when fully retracted – this is normal.

Note:

There are two different adjustments available due to different awning models - Please follow the correct adjustments, view diagrams below.

Adjustment 1:

1. Loosen the 17mm locking nuts on both sides of the arms and then turning the 13mm jack bolts to the desired angle.
2. Check the built-in spirit level in the middle on the front bar of the awning. Damage could result if the front bar isn't horizontal.
3. Adjust the arm until the front side is level.
4. Securely tighten up the 17mm locking nuts.

Adjustment 2:

1. Make sure the eyelet rings are inserted into the aperture using the pins provided (2 x eyelet rings, 2 x pins). Use the winder to turn the eyelet ring as shown in the diagram to adjust the angle.

Note:

You will notice one eyelet is already installed on the left hand side of the awning, use the winder to extend and retract the awning.

2. Adjust the angle by using the winder handle and hook around the wrist ring - turn one direction for desired slope. Now adjust the other side. Use the built-in spirit level located on the centre of the front bar to assist your desired angle.

Note:

Make sure all the angle is adjusted at the same level - any slight mis-alignment will result in the awning not retracting properly or when the awning is fully projected, one side of the front bar will be higher than the other. Ideally, project the awning fully out and then adjust the level of the front bar by eye.

Adjustment

Side view of adjustment 1

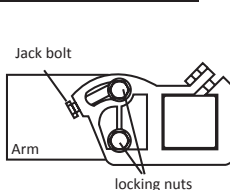

Side view of adjustment 2

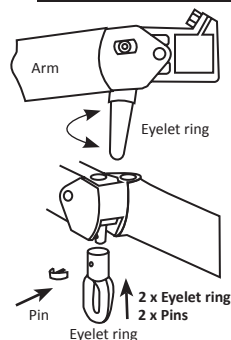

Step 6: How far out can the awning open?

With the budget awnings, you can control the position of the awning by simply winding out as far you want to go. The awning will hold at whichever position you wind to.

When the awning is fully extended, the arms are supposed to have a slight bend (not straight).

General care & precautions

Once the awning is installed, it is important to note how to properly care for the components, to make your awning work as long and efficiently as it can. The awnings are constructed from weather resistant powdercoated metal and hard-wearing polyester fabric, and are designed to give many years of service. Stains and bird droppings etc. can easily be washed or sponged away, and should not be left for prolonged periods. The awning should always be retracted in severe weather conditions.

The hook shaft, gearbox and joints on awnings should be sprayed with silicone in order to lubricate (4-6 months). WD-40 can also be used instead of silicone.

Framework of the awning should be cleaned at least once every year, with a soft cloth or sponge and warm water.

Fabric on the awning should be cleaned at the very least once every year. By using a mild detergent with warm water and a sponge or soft cloth, the fabric can be wiped and marks can be removed making the awning look like new.

Winter storage bags/rain covers:

The winter storage bag keeps your awning in pristine condition whenever it is not being used, either during the winter months or for any long period of time, significantly extending the life of your awning. Available from your supplier.

The fabric is made from hardwearing, waterproof, rot-proof, PU and UV stabilised 300gsm polyester and is easy to sponge clean. It is 100% waterproof fabric so you can cover up your awning on wet winter days.

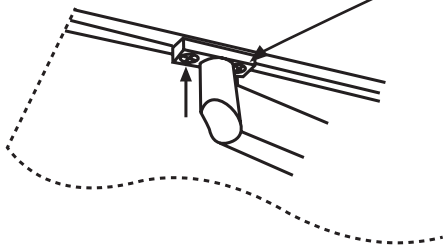

FAQ's

1. The arms aren't straight when its fully extended, is that right?

The arms are designed to remain at an angle when fully extended, this is for extra stability.

2. Can I convert this awning to electric at a later stage?

Unfortunately it isn't possible to convert a manual awning into a electric, please purchase an electric version (you can operate using a winder and remote control).

3. Is it possible to remove the winder handle off the awning?

Yes, you can unhook the winder handle and store it when not in use.

4. The fabric is sagging, how can I solve this problem?

Check and make sure the awning isn't over extended (the fabric will feed from the bottom of the roller if you over extend the awning and the fabric will sag. The fabric should always feed from the top of the roller.)

Or

The fabric is not tight enough. Make sure the fabric is rolled tightly on the metal roller.

5. My awning doesn't retract back in properly, what can I do?

Check and make sure the arms are levelled. (A spirit level is located on front bar. View step 5.)

Or

Extend the awning until it's fully projected – loosen 2 screws (don't take them out) on the left and right arm located on the front bar (diagram below) Now retract the awning back in. Once fully retracted, tighten up the 4 screws.

Or

It's possible an arm is faulty, you will have to replace the arm.