

## Awning Instructions

# Doublesided

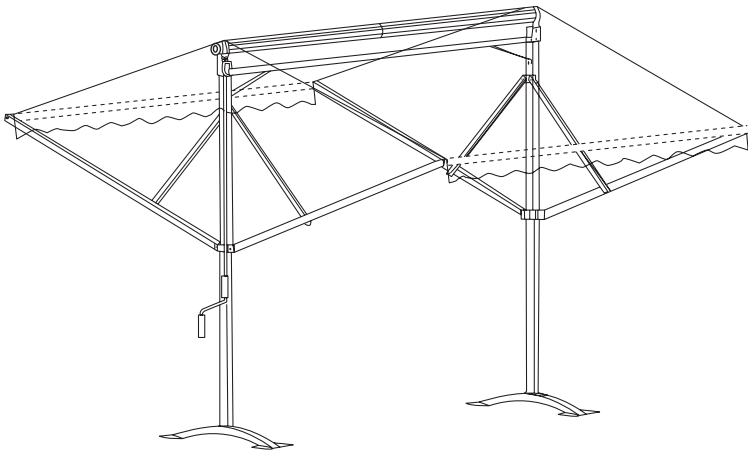

## Double Sided Awning Instructions

### Contents

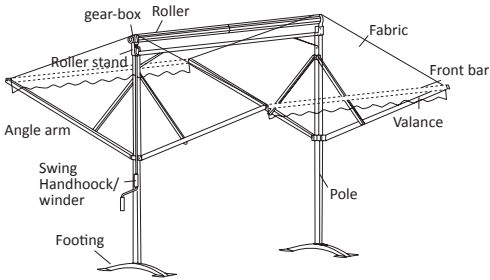

### Warning

We recommend that two people are required to assemble this awning.

The awning and frame may be supplied with a plastic wrapper. This should be removed prior to use.

Plastic bags can be dangerous to children and babies. Keep out of the reach of babies and children to avoid the risk of suffocation.

Before assembly, check that all parts are contained within the box. If any parts are found to be damaged or missing.

We recommend to install your double sided awning into the ground to prevent the awning from collapsing over.

Securely bolt the bases into concrete slabs, it is also possible to attach the awning onto railway sleepers, wooden decking, garden slabs etc.

### Guarantee

This awning is guaranteed against faulty parts and workmanship for one year from the date of delivery. Faulty parts will be replaced or exchanged within that period. The guarantee covers domestic use only.



# Assembling Double Sided Awning

# How far out can the awning open?

With the double sided manual awnings, you can control the position of the awning by simply winding out as far you want to go. The awning will hold at whichever position you wind to.

## General care & precautions

Once the awning is installed, it is important to note how to properly care for the components, to make your awning work as long and efficiently as it can. The awnings are constructed from weather resistant powder-coated metal and hard-wearing polyester fabric, and are designed to give many years of service. Stains and bird droppings etc. can easily be washed or sponged away, and should not be left for prolonged periods. The awning should always be retracted in severe weather conditions.

The hook shaft, gearbox and joints on awnings should be sprayed with silicone in order to lubricate (4-6 months). WD-40 can also be used instead of silicone.

Framework of the awning should be cleaned at least once every year, with a soft cloth or sponge and warm water.

Fabric on the awning should be cleaned at the very least once every year. By using a mild detergent with warm water and a sponge or soft cloth, the fabric can be wiped and marks can be removed making the awning look like new.

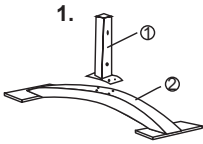

Fig 1. Assemble and connect part 1 & 2 together using M10 x 40mm bolts. This will form part of a leg (base for awning) Repeat process to form the other leg.

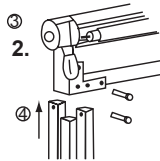

Fig 2. Insert roller part 3 over the top of the upright post (mid section no.4) connect both parts together using M8 x 60mm bolts Repeat same process and connect the other side.

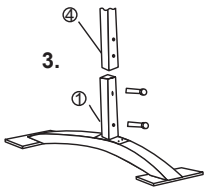

Fig 3. Two people will be required to complete this step. Connect the mid sections (no.4) with the upright legs, (left/right) by using M8 x 50mm bolts. Do not attempt to lift this unit onto legs without assistance.

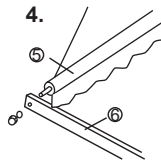

Fig 4. Connect the angle bar (no.6, left and right) onto the end of the front bar part no.5. Repeat same process to connect the opposite side.

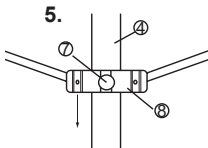

Fig 5. To adjust the height / angle arm (no.6) Loosen the screw part no.7, use the winder to project the fabric (adjustment bar part no.8 will move accordingly) Once the height is set tighten up screw, part no.7.

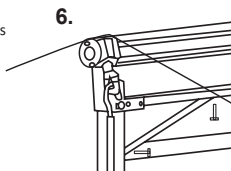

Fig 6. Use screw M8 x 50mm bolt and M8 x 35mm to install the slanted bars on both sides. The awning is now assembled and ready to use.